

Data Sheet



Article number: 604133038055

Description: Taper bored timing belt pulley
HTD 38 14M 55 TL 2517

Measures

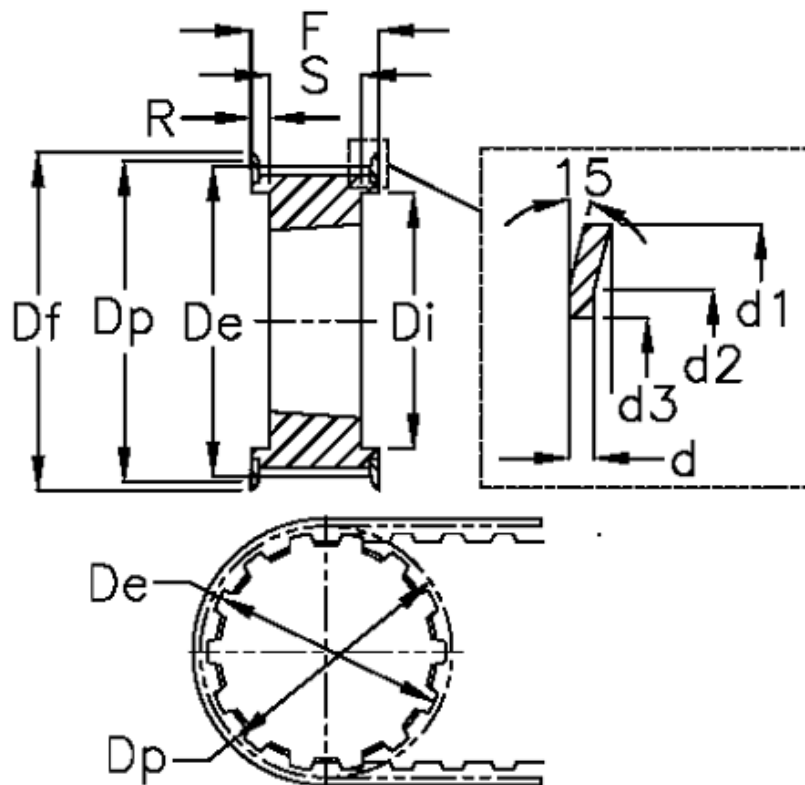

$d = 2.5$	F = 70	Weight = 6.2
$d1 = 184$	Flange type = F55	Width = 55
$d2 = 168$	For bushing = 2517	
$d3 = 135$	Max bore = 60	
$De = 166.6$	r = 12.5	
$Df = 184$	S = 45	
$Di = 130$	Tooth number = 38	
$Dp = 169.34$	Type = 14M	